



 **GRABER**<sup>®</sup>  
DRAPERY HARDWARE COLLECTION



## An Enduring LEGACY

*From its humble beginning as the creator of the “Badger Crane” in 1939, Graber has evolved into one of the leading drapery hardware manufacturers of the 21st century. The Graber family founded the company on principles of quality and innovation. That simple approach lives on today.*

## A Commitment to QUALITY

*Our commitment to quality is steeped in tradition. Whether it’s inspiration you seek or innovation you crave, energize your creative spirit with the Drapery Hardware Collection.*



## Discover the Beauty and Quality of DRAPERY HARDWARE

Nobility Collection™ .....	4
Finishes .....	8
Mission Collection .....	10
Regal Collection .....	11
Elite and Woodware Collections .....	12
Decorative Traverse and Café Rods .....	14
Traverse Rods .....	16
Dauphine®, Wide Pocket, and Curtain Rods .....	18
Graber Frameworks® .....	20





# GRABER NOBILITY COLLECTION™

Turn a simple window into a sensational one! Elegantly traditional or classically casual, the Nobility Collection enhances the décor of any room with beautiful designs made exclusively for Graber.

Transform windows into unique works of art – choose the dramatic antique gold finish, the distinctive soft silver finish, the timeless stone finish, or one of several combination specialty finishes.

Finials are designed to be used with multiple pole diameters – converter rings are provided with each finial to increase their versatility.

D-profile poles are flat on the back to prevent soft window treatments from twisting and turning on pole.

Stylish cap finials are a perfect solution when space is at a premium.

Swivel brackets are easy to install – just screw plate to wall, screw in bracket, and swivel to correct upright position.

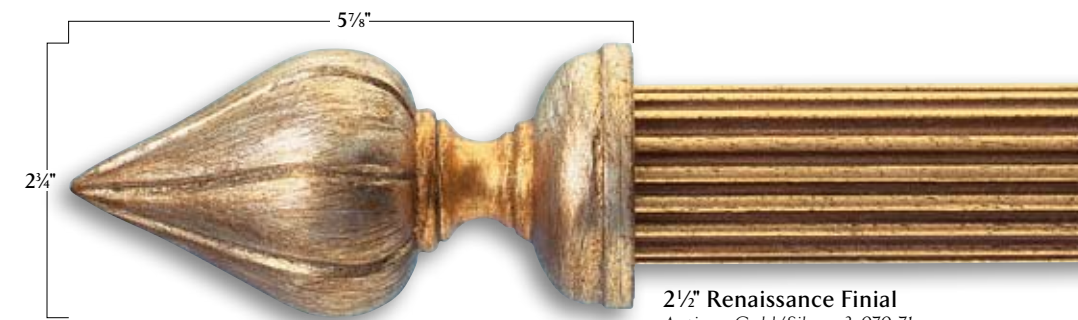

**2 1/2" Renaissance Finial**  
Antique Gold/Silver 3-070-71



**2 1/2" Morocco Finial, Large**  
Soft Silver 3-119-65  
Available in: (53), (65), (71)

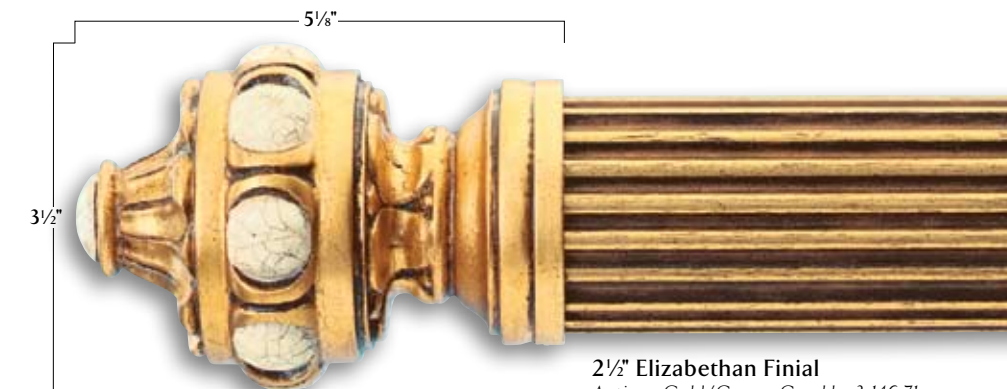

**2 1/2" Elizabethan Finial**  
Antique Gold/Cream Crackle 3-146-71

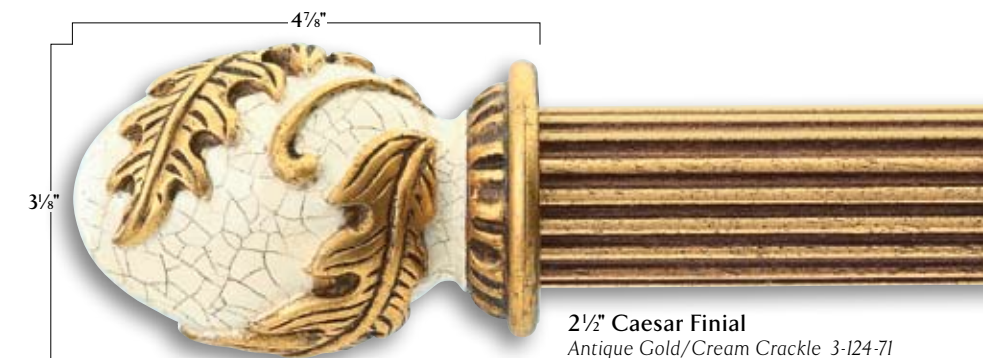

**2 1/2" Caesar Finial**  
Antique Gold/Cream Crackle 3-124-71

2 1/2" poles come in 6' & 8' lengths.  
All sizes available in: (53), (65), (71).





# NOBILITY COLLECTION™

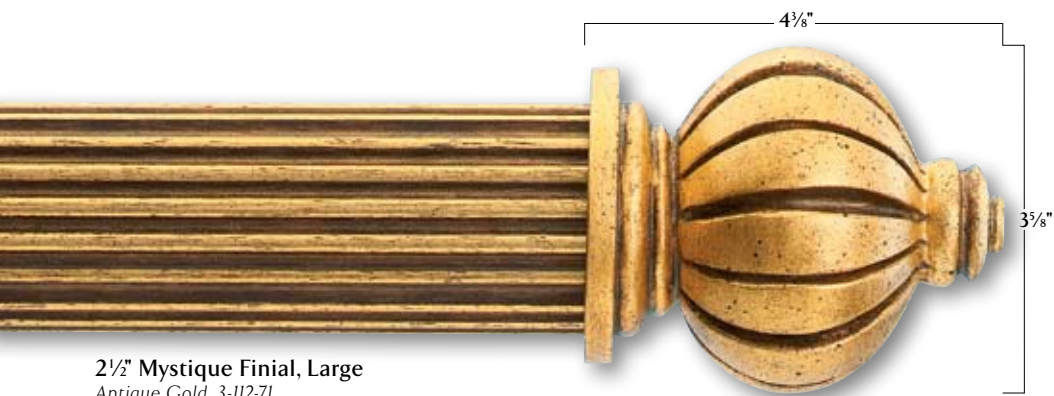

**2 1/2" Mystique Finial, Large**  
Antique Gold 3-112-71  
Available in: (53), (65), (71)

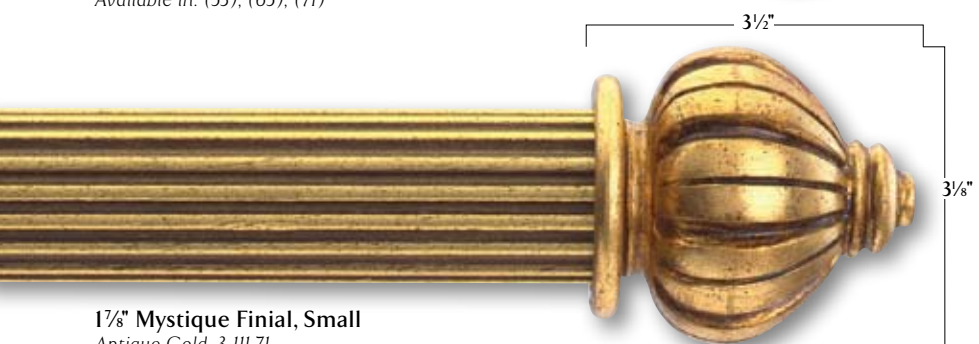

**1 7/8" Mystique Finial, Small**  
Antique Gold 3-111-71

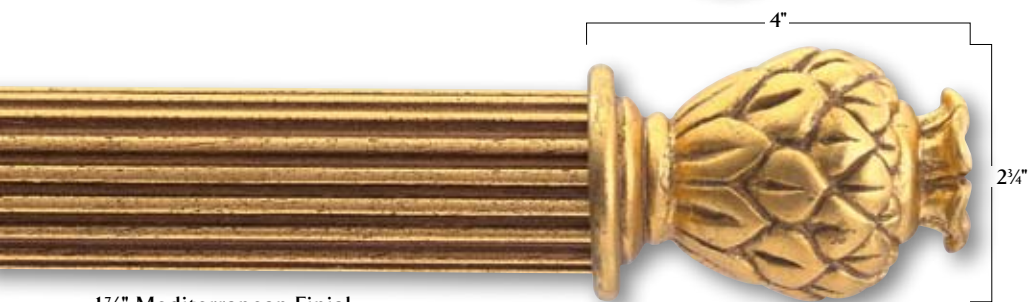

**1 7/8" Mediterranean Finial**  
Antique Gold 3-229-71



**2 1/2" Cap Finial**  
Stone 3-078-53  
Available in: (53), (65), (71)



**1 7/8" Cap Finial**  
Antique Gold 3-077-71

2 1/2" poles come in 6' & 8' lengths.  
All sizes available in: (53), (65), (71).

1 7/8" poles come in 6' & 8' lengths.  
All sizes available in: (71).



## ACCESSORIES



**Elizabethan Holdback**  
Antique Gold/Cream Crackle 3-200-71  
5 1/4" Diameter, 3 1/4" Clearance, 5 1/4" Projection



**2 1/2" Swivel Bracket**  
Stone 3-073-53  
Available in: (53), (65), (71)  
3 1/2" Clearance, 5 1/4" Projection, 6 1/4" Length  
**1 7/8" Swivel Bracket**  
Antique Gold 3-072-71  
3 3/8" Clearance, 5 1/4" Projection, 5 7/8" Length

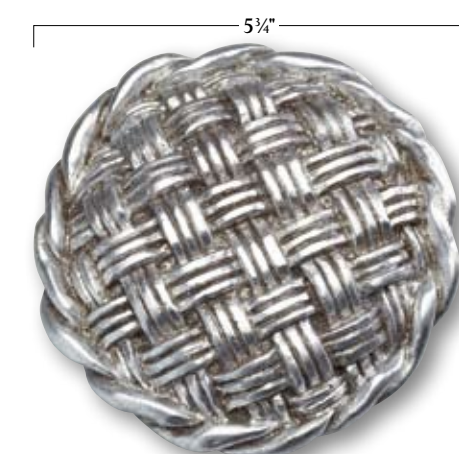

**Morocco Holdback**  
Soft Silver 3-099-65  
Available in: (65), (71)  
5 7/8" Diameter, 3 1/4" Clearance, 4 7/8" Projection



**2 1/2" Rings**  
Antique Gold 3-095-71  
Available in: (53), (65), (71)  
ID 2 7/8", OD 4 3/8", Hang 4 1/8"  
**1 7/8" Rings**  
Antique Gold 3-094-71  
ID 2 1/2", OD 3 1/4", Hang 3 1/2"

## FINISHES



Stone (53)



Soft Silver (65)



Antique Gold (71)

Finishes and colors depicted on printed page may not be an exact reproduction of actual colors. See a Graber Drapery Hardware Selector to match actual colors.

See Graber Drapery Hardware Price List for additional details including available sizes. All poles and finials are approximately 50% of actual size.



# FINISHES

## EXPERIENCE THE DIFFERENCE

The Graber Difference is in the details. Nothing highlights this more than our beautiful drapery hardware pole finishes. From beautiful metallics to rich mahoganies, from warm oaks to matte blacks, and natural finishes you can customize - there's a beautiful finish to meet your needs.



Unfinished Natural (0), (00)



Warm Oak (48)



White (1)

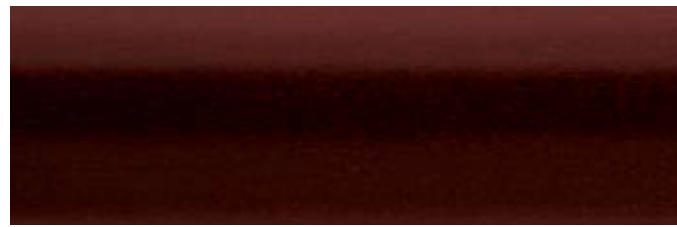

Cherry (77)

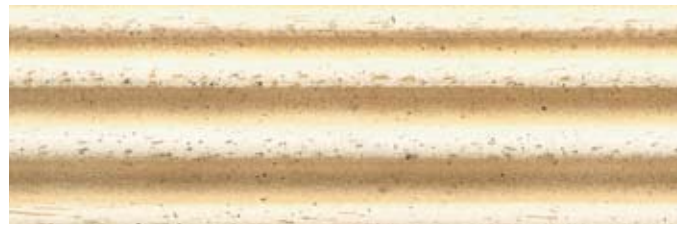

Stone (53)



Mahogany (18)



Soft Silver (65)



Matte Black (39)

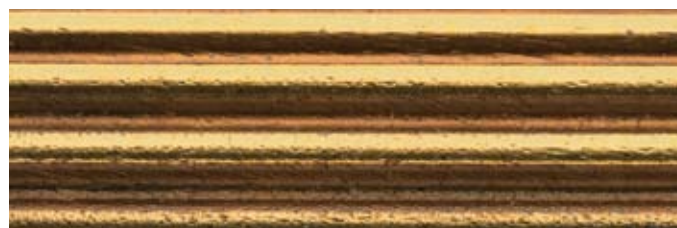

Antique Gold (71)

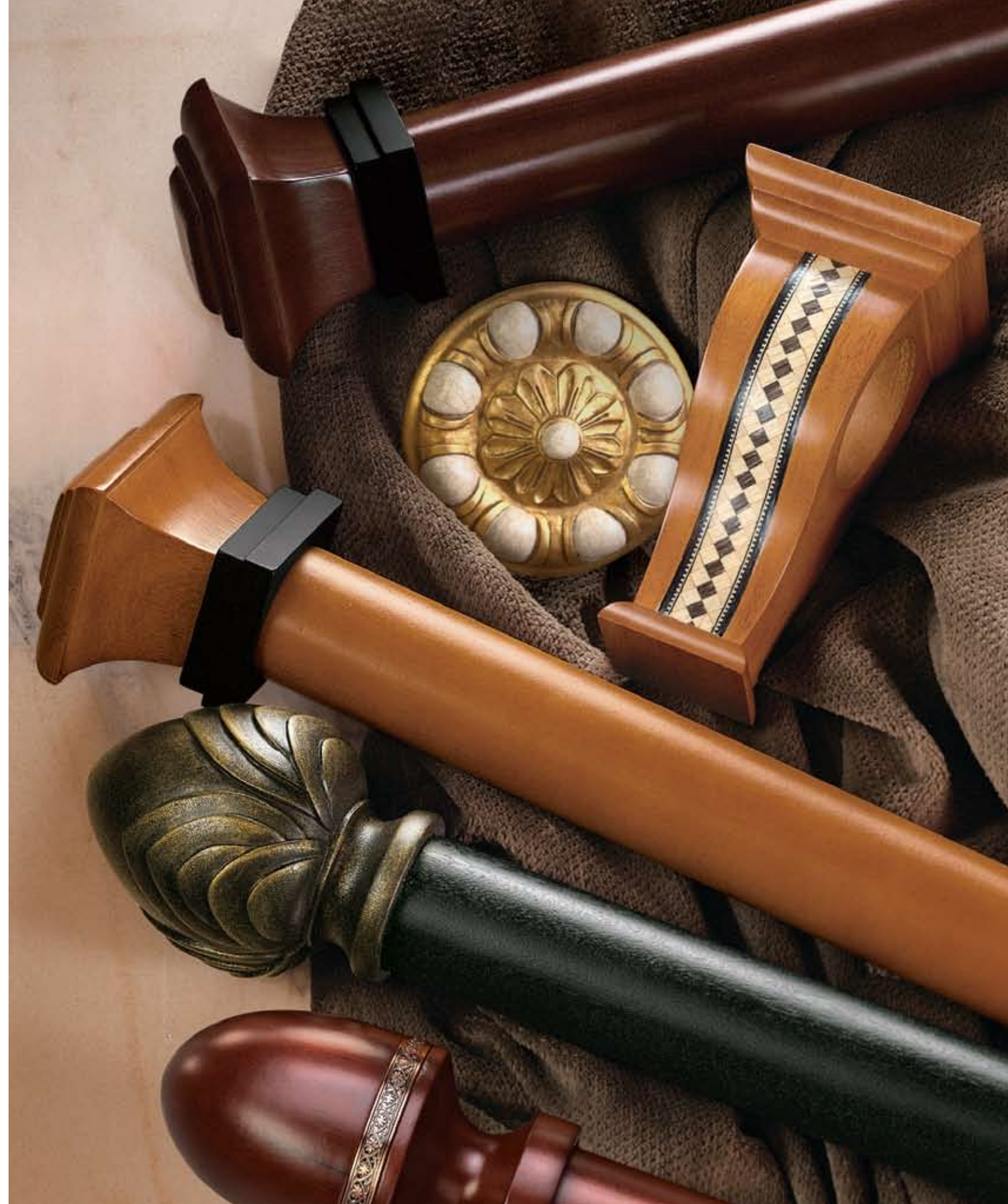

Finishes and colors depicted on printed page may not be an exact reproduction of actual colors. See a Graber Drapery Hardware Selector to match actual colors.

See Graber Drapery Hardware Price List for additional details including available sizes. All poles and finials are approximately 50% of actual size.



# MISSION COLLECTION

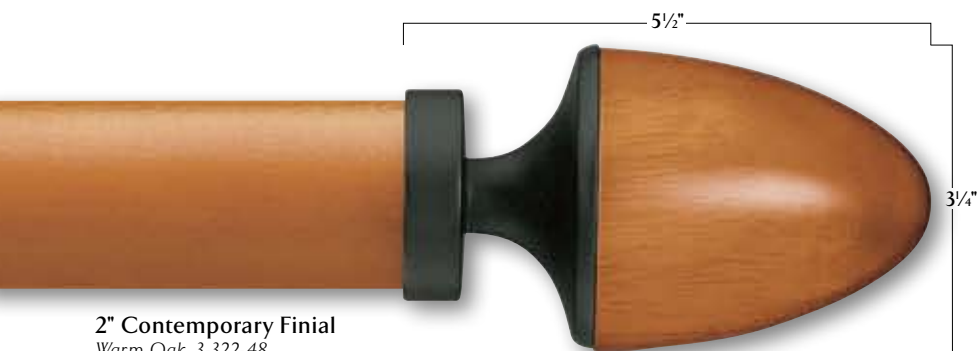

**2" Contemporary Finial**  
Warm Oak 3-322-48  
Available in: (18), (48)

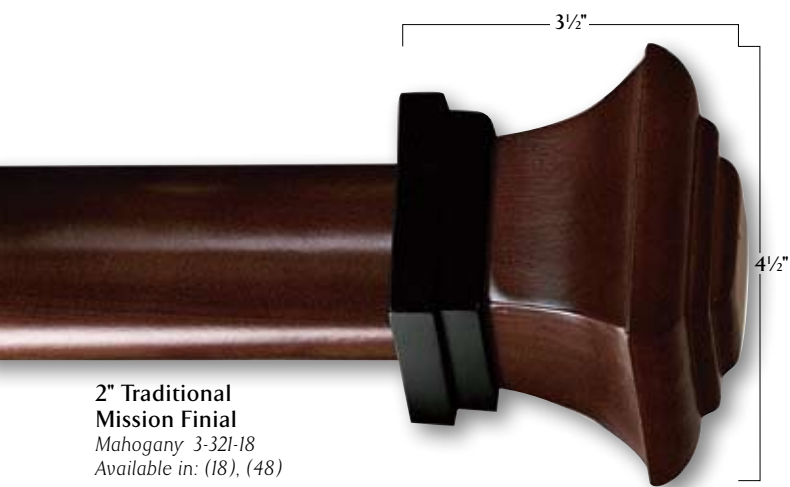

**2" Traditional Mission Finial**  
Mahogany 3-321-18  
Available in: (18), (48)



**2" Traditional Finial**  
Matte Black 3-108-39  
Available in: (18), (39), (48)



**2" Round Finial**  
Matte Black 3-107-39  
Available in: (18), (39), (48)

2" poles come in 6' 8" & 12' lengths.  
All sizes available in: (18), (39), (48).



## FINISHES

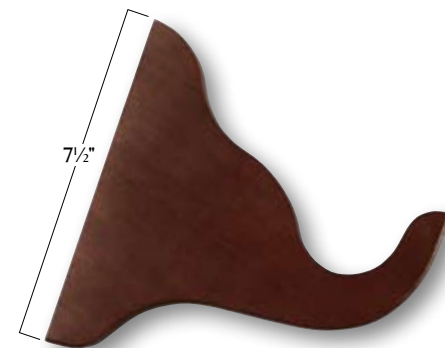

**2" Traditional Bracket**  
Mahogany 3-230-18  
Available in: (18), (48)  
4 1/2" Clearance, 6 1/2" Projection, 7 1/2" Length

## ACCESSORIES

See page 13 for wood rings.

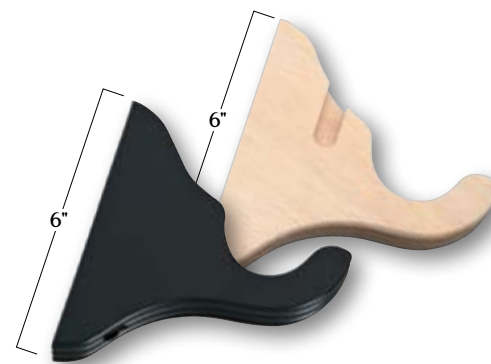

**2" Wood Bracket 5" projection**  
Matte Black 3-135-39 (Shown)  
Unfinished Natural 3-135(8)-0 (Shown)  
Available in: (0), (1), (39), (77)  
3" Clearance, 1 1/8" Sheer Clearance,  
5" Projection 2 1/8" Sheer Projection, 6" Length

**2" Wood Bracket 8" projection**  
3-137  
Available in: (0), (1)  
6" Clearance, 4 1/2" Sheer Clearance,  
8" Projection 5 1/8" Sheer Projection, 9 1/8" Length



**Inlaid Wood Bracket**  
Mahogany 3-651-18  
Available in: (18), (48)



**2" Metal Bracket**  
Black 9-251-39  
Available in (39)  
4-5 1/2" Clearance,  
6-7 1/2" Projection, 7-8 1/2" Length

# REGAL COLLECTION

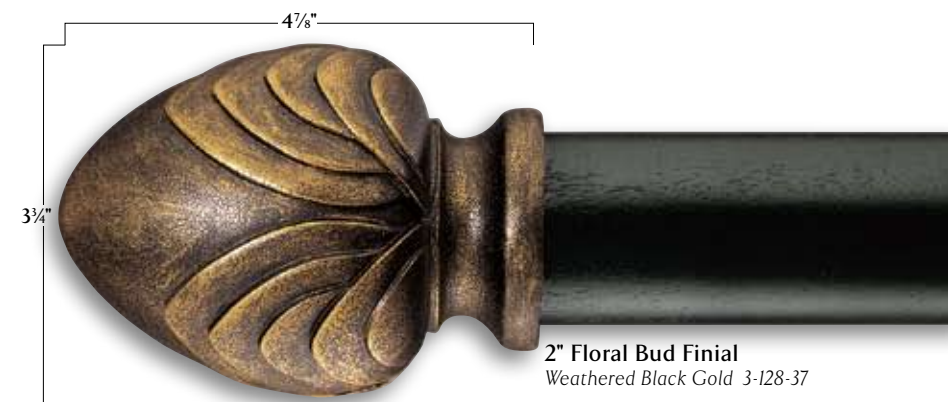

**2" Floral Bud Finial**  
Weathered Black Gold 3-128-37



**2" Crown Finial**  
Weathered Black Gold 3-115-37



# ELITE COLLECTION

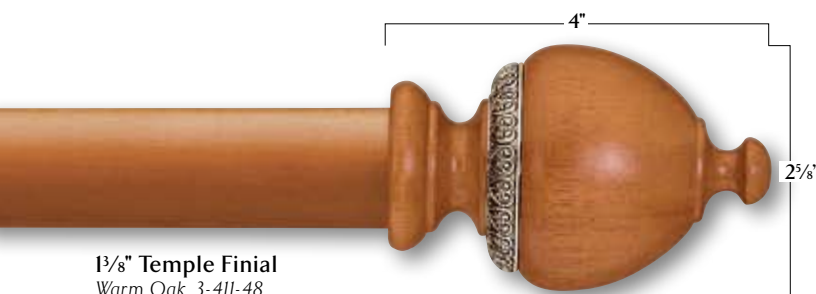

**1 3/8" Temple Finial**  
Warm Oak 3-411-48  
Available in: (48), (77)

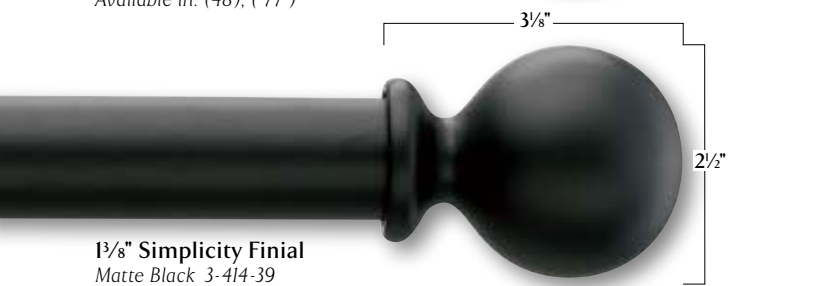

**1 3/8" Simplicity Finial**  
Matte Black 3-414-39  
Available in: (39)

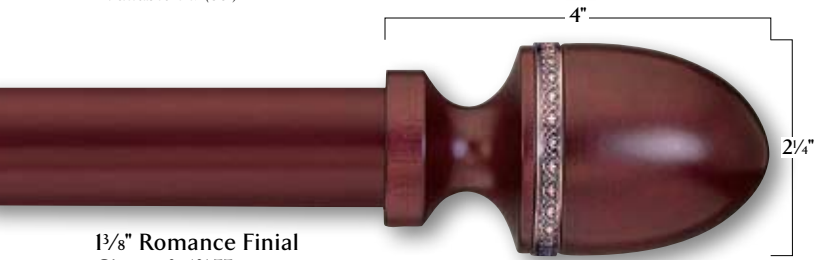

**1 3/8" Romance Finial**  
Cherry 3-431-77  
Available in: (48), (77)

# WOODWARE COLLECTION

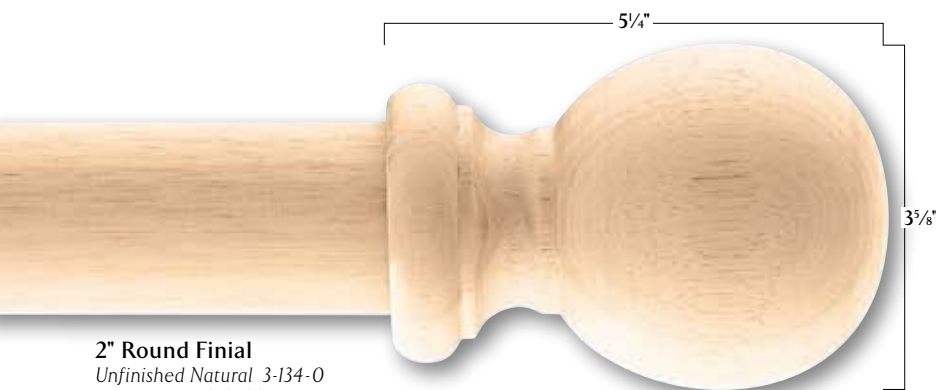

**2" Round Finial**  
Unfinished Natural 3-134-0  
Available in: (0), (1)

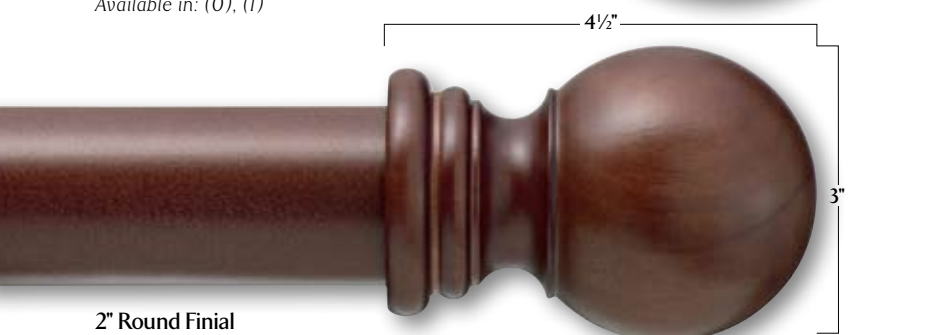

**2" Round Finial**  
Mahogany 3-107-18  
Available in: (18), (48)

## ACCESSORIES



**1 3/8" Rounded Wood Bracket**  
Warm Oak 3-554-48  
Available in: (39), (48), (77)  
3" Clearance, 4 1/8" Projection, 5" Length



**1 3/8" Adjustable Wood Bracket**  
Cherry 3-6495-77  
Available in: (0), (77)  
4 1/8"-6" Clearance, 6 1/4"-7 1/8" Projection, 6 7/8"-8" Length

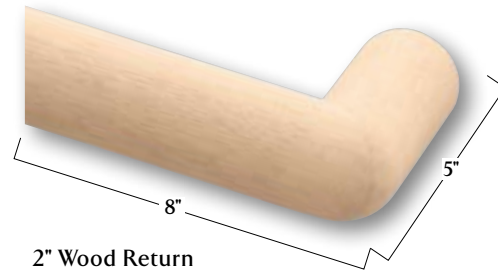

**2" Wood Return**  
Unfinished Natural 3-142-0  
Available in: (0)

## HOLDBACK



**Round**  
Unfinished Natural 3-2048-0  
3 3/8" Diameter, 3 1/8"-5 3/8" Clearance, 3 3/8"-6" Projection

See page 11 for 2" wood brackets



**1 3/8" Wood Ring**  
Matte Black 3-553-39  
Available in: (39), (48)  
3-552  
Available in: (0), (77)  
ID 1 1/4", OD 2 1/4", Hang 2 1/2"

**2" Wood Ring**  
White 3-140(8)-1  
Available in: (0), (1), (77)  
ID 2 1/8", OD 3 1/4", Hang 3 3/8"

**2" Wood Ring**  
3-511  
Available in: (18), (39), (48)  
ID 2 1/8", OD 3 1/2", Hang 3 3/8"

## FINISHES

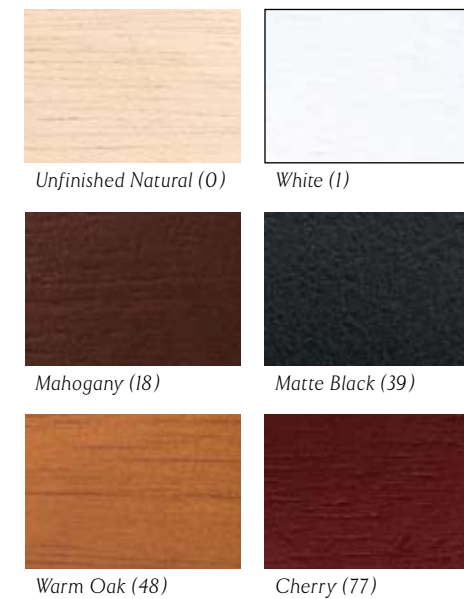

2" poles come in 6', 8' & 12' lengths.  
All sizes available in: (0), (18), (48), (77).  
(1) only available in 6' & 8'

1 3/8" poles come in 6' & 8' lengths.  
All sizes available in: (0), (39), (48), (77).  
(77) also available in 4'

# WOODWARE COLLECTION

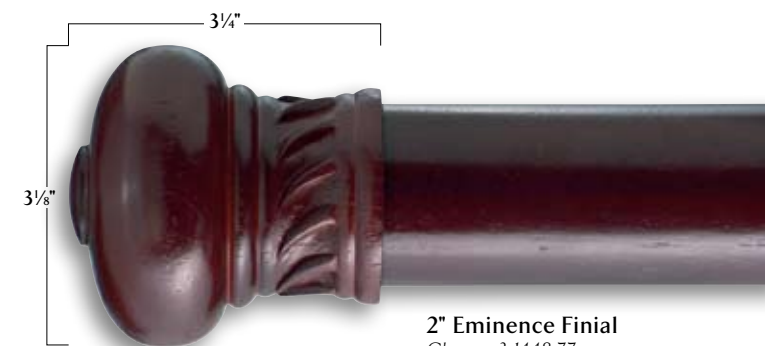

**2" Eminence Finial**  
Cherry 3-1448-77  
Available in: (0), (77)

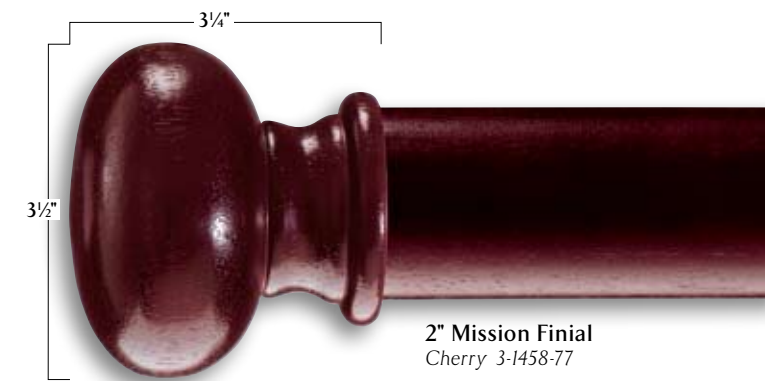

**2" Mission Finial**  
Cherry 3-1458-77

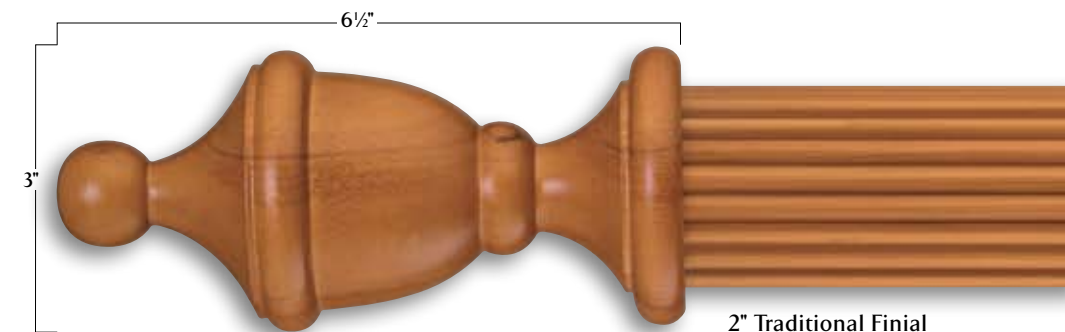

**2" Traditional Finial**  
Warm Oak 3-108-48  
Available in: (00), (18), (48)

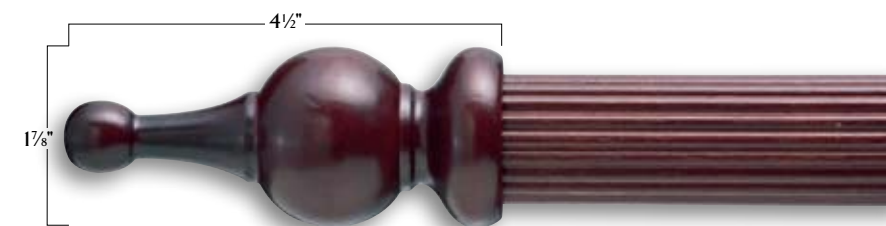

**1 3/8" Decorative Finial**  
Cherry 3-541-77  
Available in: (0), (77)



# DECORATIVE TRAVERSE AND CAFÉ RODS

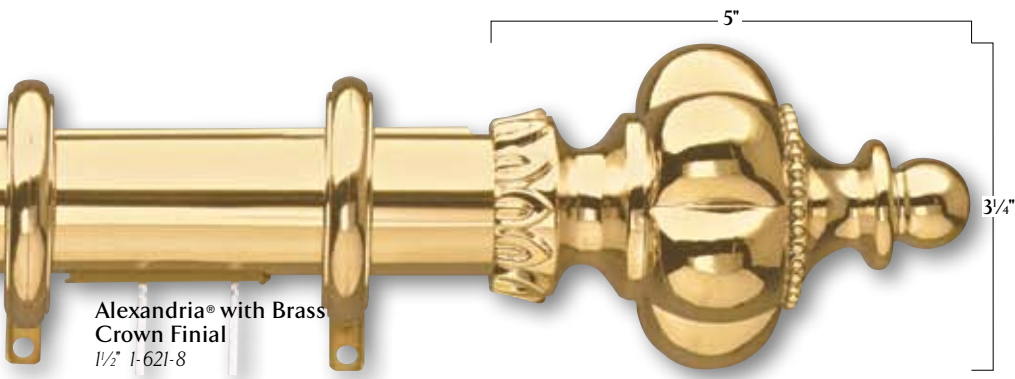

**Alexandria® with Brass Crown Finial**  
1/2" 1-621-8

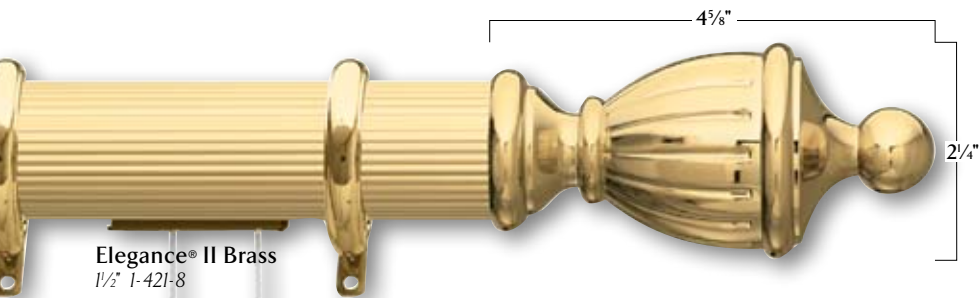

**Elegance® II Brass**  
1/2" 1-421-8

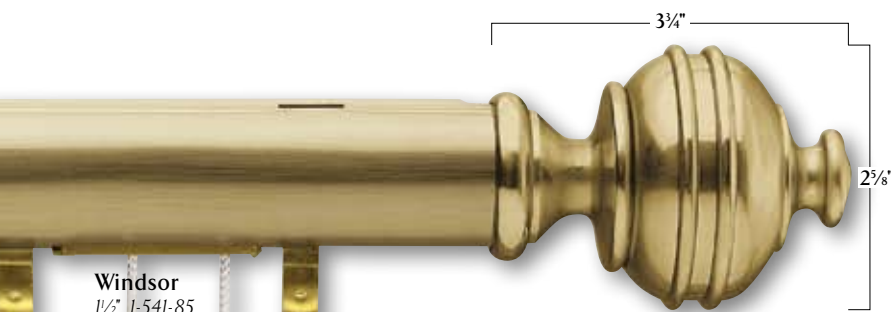

**Windsor**  
1/2" 1-541-85  
Available in:  
(8), (39), (45), (85)

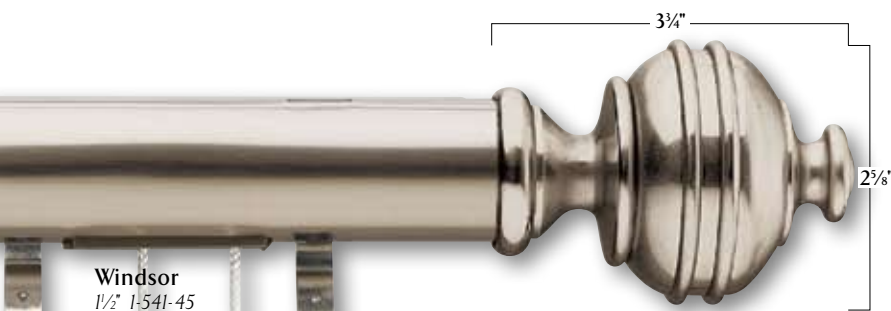

**Windsor**  
1/2" 1-541-45  
Available in:  
(8), (39), (45), (85)

## ACCESSORIES



**Metal Cafe Clips, Round**  
Brass Finish 5-740-8  
Available in: (8), (78)  
ID 1", OD 1 1/8", Hang 1 1/2"



**Magic™ Swagholder**  
Bright Brass Finish 8-212-81  
4 1/2"-8" clearance



**Cafe Rings, with Eye**  
Brass Finish 5-810-8  
ID 1 1/4", OD 2 1/4", Hang 2 1/2"

## DECORATIVE PLASTIC HOLDBACK



**Peacock**  
3" clearance  
Antique Gold Finish 8-291-7

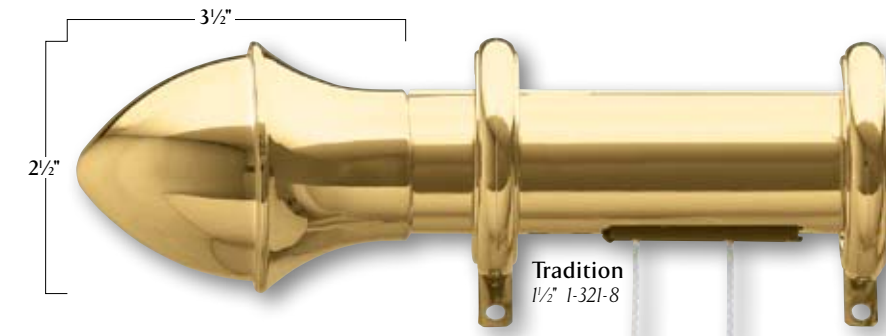

**Tradition**  
1/2" 1-321-8

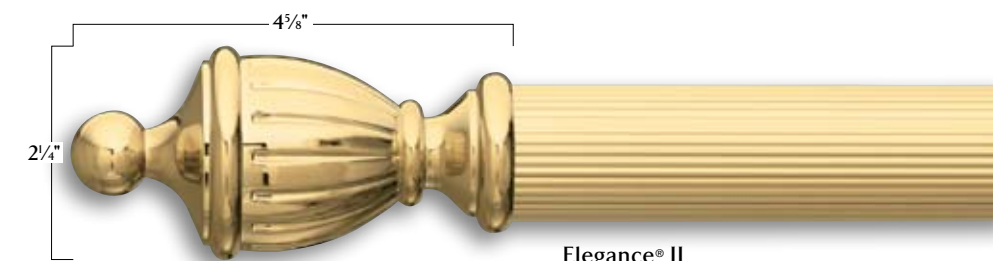

**Elegance® II**  
1/2" 2-421-8



**Windsor**  
1/2" 2-509-8  
C-Rings Available for Swag  
2-528-8



**Tradition**  
3/4" 2-461-78 (Shown)  
Available in: (8), (78)  
1/2" 2-480  
Available in: (1), (8), (78)



Finishes and colors depicted on printed page may not be an exact reproduction of actual colors. See a Graber Drapery Hardware Selector to match actual colors.

See Graber Drapery Hardware Price List for additional details including available sizes. All poles and finials are approximately 50% of actual size.



# TRAVERSE RODS

Flex Rod  
0-002-1



Heavy Duty  
Baton Draw  
Traverse Rod  
0-443-1



Super Heavy Duty  
Traverse and Plain Rod  
0-611-1



Heavy Duty Traverse  
and Dauphine® Rod  
0-491-1

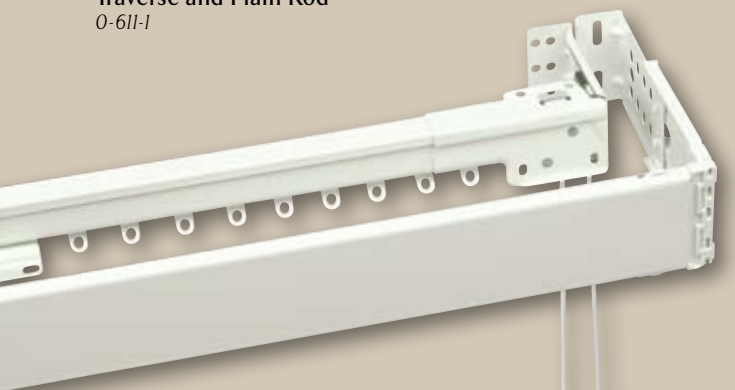

Sheer Rod Kit  
0-781-1



Super Heavy Duty  
Double Traverse Rod  
0-621-1

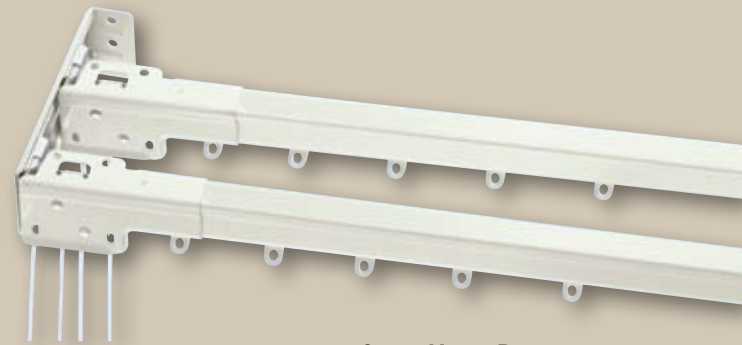

Super Heavy Duty  
Traverse and Valance Rod  
0-631-1

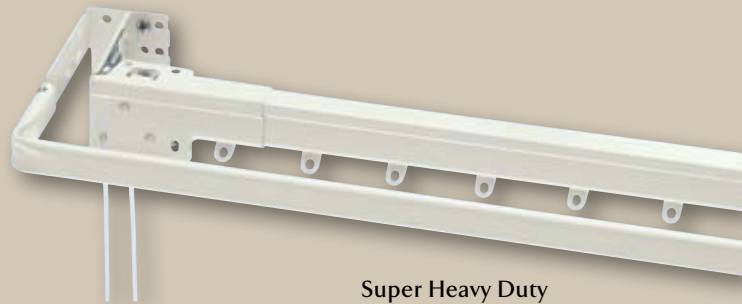

Super Heavy Duty Rod  
0-601-1  
Heavy Duty Rod  
0-401-1



Regular Duty Rod  
0-701-1

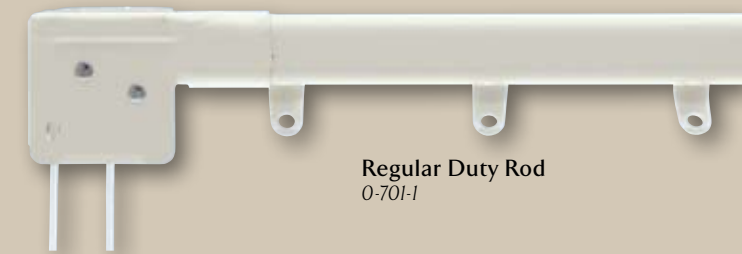

Finishes and colors depicted on printed page may not be an exact reproduction of actual colors. See a Graber Drapery Hardware Selector to match actual colors.

See Graber Drapery Hardware Price List for additional details including available sizes.



# DAUPHINE®, WIDE POCKET, AND CURTAIN RODS



2 1/2" Dauphine Rod  
4-721-1



2 1/2" Economy  
Wide Pocket Rod  
4-712-12



4 1/2" Dauphine Rod  
4-741-1

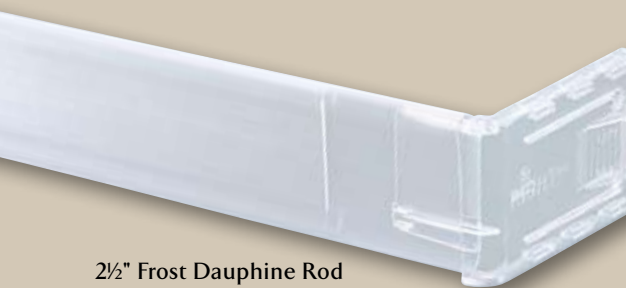

2 1/2" Frost Dauphine Rod  
4-782-1



2 1/2" Dauphine Bay/Bow  
Window Set  
4-711-1

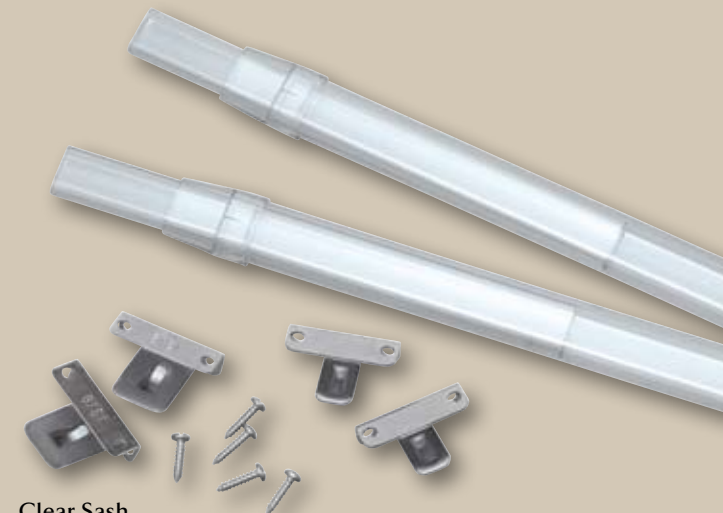

Clear Sash  
4-600-1

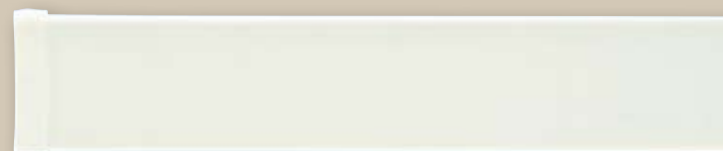

2 1/2" Spring Tension  
Dauphine Rod  
4-791-1



Specialty Window  
Hardware Kit  
4-024-1



## CURTAIN RODS

Available as double and triple curtain rod applications and with additional projections to fill a variety of decorating needs.



2 1/2" Projection Rod  
Clear Single 4-122-1



5 1/2" Projection Rod  
Lock-Seam 4-252-1



2 1/2" Projection Rod  
Hemmed 4-421-1



Crystal Clear™  
Arch 4-022-1





5/8" DECORATIVE ROD SETS & HOLDBACKS

5/8" DECORATIVE ROD SETS & HOLDBACKS

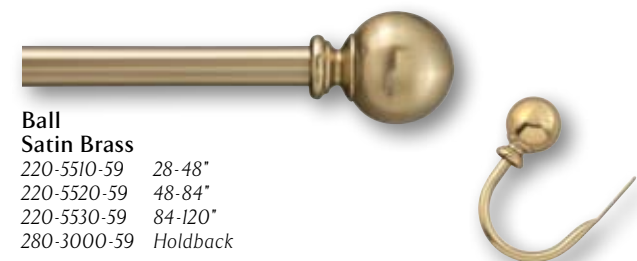

**Ball Satin Brass**  
220-5510-59 28-48"  
220-5520-59 48-84"  
220-5530-59 84-120"  
280-3000-59 Holdback

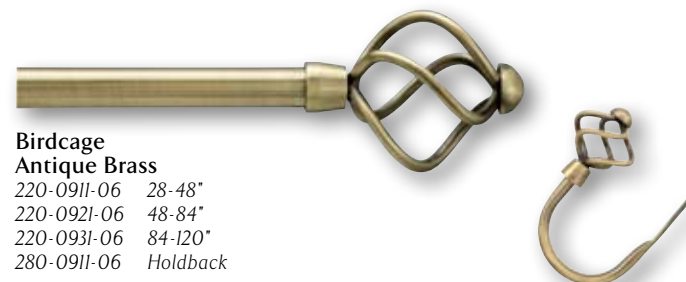

**Birdcage Antique Brass**  
220-0911-06 28-48"  
220-0921-06 48-84"  
220-0931-06 84-120"  
280-0911-06 Holdback



**Spiral Cream**  
220-0411-61 28-48"  
220-0421-61 48-84"  
220-0431-61 84-120"  
280-0411-61 Holdback



**Leafy Fan Black/Gold**  
220-0711-39 28-48"  
220-0721-39 48-84"  
220-0731-39 84-120"  
280-0711-39 Holdback

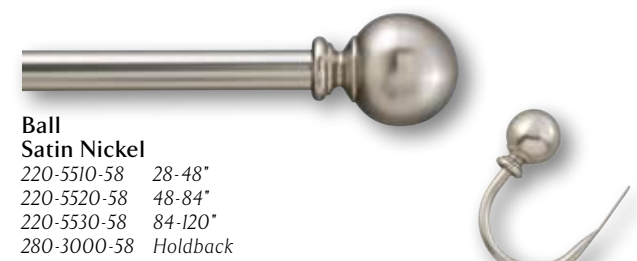

**Ball Satin Nickel**  
220-5510-58 28-48"  
220-5520-58 48-84"  
220-5530-58 84-120"  
280-3000-58 Holdback

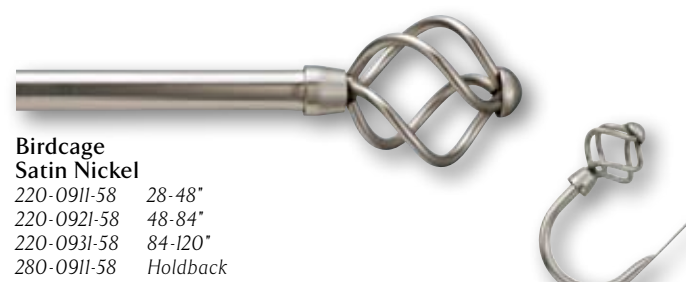

**Birdcage Satin Nickel**  
220-0911-58 28-48"  
220-0921-58 48-84"  
220-0931-58 84-120"  
280-0911-58 Holdback

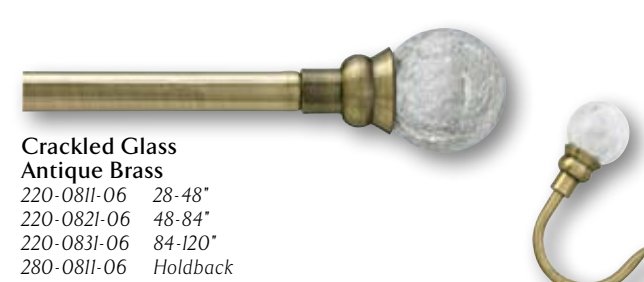

**Crackled Glass Antique Brass**  
220-0811-06 28-48"  
220-0821-06 48-84"  
220-0831-06 84-120"  
280-0811-06 Holdback



**Cambridge Black**  
220-0211-39 28-48"  
220-0221-39 48-84"  
220-0231-39 84-120"  
280-0211-39 Holdback



**Ball Black**  
220-5510-57 28-48"  
220-5520-57 48-84"  
220-5530-57 84-120"  
280-3000-57 Holdback



**Square Nickel**  
220-1111-78 28-48"  
220-1121-78 48-84"  
220-1131-78 84-120"  
280-1111-78 Holdback

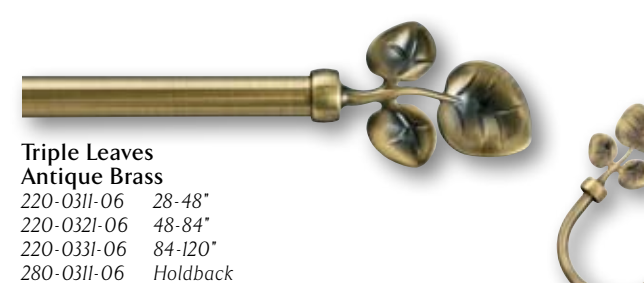

**Triple Leaves Antique Brass**  
220-0311-06 28-48"  
220-0321-06 48-84"  
220-0331-06 84-120"  
280-0311-06 Holdback

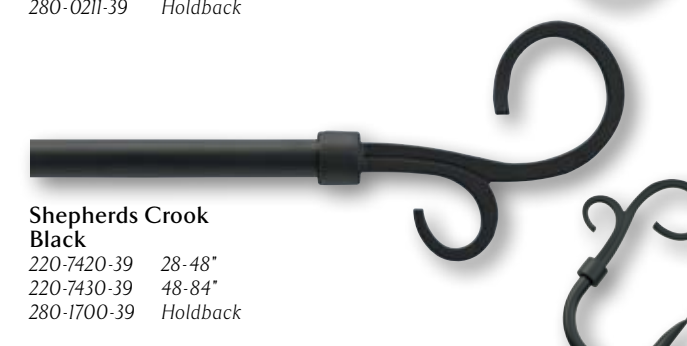

**Shepherds Crook Black**  
220-7420-39 28-48"  
220-7430-39 48-84"  
280-1700-39 Holdback



**Scroll Black**  
220-0011-39 28-48"  
220-0021-39 48-84"  
220-0031-39 84-120"  
280-0011-39 Holdback



**Morgan Nickel**  
220-0511-78 28-48"  
220-0521-78 48-84"  
220-0531-78 84-120"  
280-0511-78 Holdback



**Urn Rustic Antique Brass**  
220-0111-32 28-48"  
220-0121-32 48-84"  
220-0131-32 84-120"  
280-0111-32 Holdback



**Multiple Leaf Black**  
220-7840-3 28-48"  
220-7850-3 48-84"  
280-1280-3 Holdback



**Scroll Nickel**  
220-0011-78 28-48"  
220-0021-78 48-84"  
220-0031-78 84-120"  
280-0011-78 Holdback



**Classic Square Black**  
220-1011-39 28-48"  
220-1021-39 48-84"  
220-1031-39 84-120"  
280-1011-39 Holdback



**Jefferson Dark Brown**  
220-0611-73 28-48"  
220-0621-73 48-84"  
220-0631-73 84-120"  
280-0611-73 Holdback



**Metal Rings with Clips**  
220-7221-61 Cream  
220-7221-58 Satin Nickel  
220-7221-59 Satin Brass  
220-7221-06 Antique Brass  
220-7221-32 Rustic Antique Brass  
220-7221-73 Brown  
220-7221-39 Black



WOOD POLE SETS



**1 1/8" Wood Pole Sets**

<b>4 ft.</b>	230-7501-10 White	230-7511-10 White
	230-7501-25 Oak	230-7511-25 Oak
	230-7501-77 Cherry	230-7510-77 Cherry



**1/2" Wood Pole Sets**

<b>4 ft.</b>	230-7701-10 White	230-7801-10 White
	230-7701-25 Oak	230-7801-25 Oak
	230-7701-77 Cherry	230-7801-77 Cherry

WOOD COMPONENTS



**1 3/8" Fluted Wood Pole**

<b>4 ft.</b>	230-5300-00 Natural	230-5310-00 Natural	230-5320-00 Natural
	230-5300-10 White	230-5310-10 White	230-5320-10 White
	230-5300-25 Oak	230-5310-25 Oak	230-5320-25 Oak
	230-5300-72 Gold	230-5310-72 Gold	230-5320-72 Gold



**1 3/8" Decorative Finials**

230-5410-00 Natural	230-5400-00 Natural
230-5410-10 White	230-5400-10 White
230-5410-25 Oak	230-5400-25 Oak
	230-5400-72 Gold



WOOD COMPONENTS



**1 3/8" European Brackets**

230-5490-00 Natural
230-5490-10 White
230-5490-25 Oak
230-5490-72 Gold



**1 3/8" Wood Rings**

230-5520-77 Cherry
230-5520-72 Gold
230-5520-10 White
230-5520-25 Oak
230-5520-00 Natural



**Mini Simple Scroll**

230-5690-11 Whitewash
230-5690-25 Oak
230-5690-77 Cherry



**Small Simple Scroll**  
230-5680-77 Cherry

**Leaf Sconce**  
230-5730-72 Gold

NOBILITY COLLECTION™

**2 1/2" Finials**

Renaissance.....	5
Morocco, Large.....	5
Elizabethan.....	5
Caesar.....	5
Mystique, Large.....	6
Cap.....	6

**1 7/8" Finials**

Mystique, Small.....	6
Mediterranean.....	6
Cap.....	6

**Accessories**

Elizabethan Holdback.....	7
Morocco Holdback.....	7
Swivel Brackets.....	7
Rings.....	7

MISSION COLLECTION

**2" Finials**

Contemporary.....	10
Traditional Mission.....	10
Traditional.....	10
Round.....	10

REGAL COLLECTION

**2" Finials**

Floral Bud.....	11
Crown.....	11

**Accessories**

2" Wood Bracket.....	11
2" Wood Ring.....	13
2" Metal Bracket.....	11
2" Wood Return.....	12
Inlaid Wood Bracket.....	11

ELITE COLLECTION

**1 3/8" Finials**

Temple.....	12
Simplicity.....	12
Romance.....	12

**Accessories**

1 3/8" Rounded Wood Bracket.....	12
----------------------------------	----

WOODWARE COLLECTION

**2" Finials**

Round.....	12
Eminence.....	13
Mission.....	13
Traditional.....	13

**1 3/8" Finials**

Decorative.....	13
-----------------	----

**Accessories**

1 3/8" Adjustable Wood Bracket.....	12
1 3/8" Wood Ring.....	13
2" Wood Ring.....	13
Round Holdback.....	13

DECORATIVE TRAVERSE AND CAFÉ RODS

Alexandria®.....	14
Elegance® II.....	14, 15
Windsor.....	14, 15
Tradition.....	15

**Accessories**

Metal Cafe Clips, Round.....	14
Cafe Rings with Eye.....	14
Magic® Swagholder.....	15
Peacock Decorative Holdback.....	15

TRAVERSE RODS

Flex Rod.....	16
Heavy Duty Baton Draw Traverse Rod.....	16
Super Heavy Duty Traverse and Plain Rod.....	16
Heavy Duty Traverse and Dauphine® Rod.....	16
Sheer Rod Kit.....	16
Super Heavy Duty Double Traverse Rod.....	16
Super Heavy Duty Traverse and Valance Rod.....	16
Super Heavy Duty Rod.....	16
Heavy Duty Rod.....	16
Regular Duty Rod.....	16

DAUPHINE®, WIDE POCKET, CURTAIN RODS

**Dauphine**

2 1/2" Dauphine Rod.....	18
2 1/2" Economy Wide Pocket Rod.....	18
4 1/2" Dauphine Rod.....	18
2 1/2" Frost Dauphine Rod.....	18
2 1/2" Dauphine Bay/Bow Window Set.....	18
Clear Sash.....	18
2 1/2" Spring Tension Dauphine Rod.....	18
Specialty Window Hardware Kit.....	18

**Curtain Rods**

2 1/2" Projection, Clear.....	19
5 1/2" Projection, Lock-Seam.....	19
2 1/2" Projection, Hemmed.....	19
Crystal Clear™.....	19

GRABER FRAMEWORKS

**5/8" Decorative Rod Sets & Holdbacks**

Ball.....	20
Scroll.....	20
Birdcage.....	20
Square.....	20
Morgan.....	20
Classic Square.....	20
Spiral.....	21
Crackled Glass.....	21
Triple Leaves.....	21
Urn.....	21
Jefferson.....	21
Leafy Fan.....	21
Cambridge.....	21
Shepherds Crook.....	21
Multiple Leaf.....	21
Metal Rings with Clips.....	21

**Wood Pole Sets**

1 1/8" Wood Pole Sets.....	22
1/2" Wood Pole Sets.....	22

**Wood Components**

Fluted Wood Poles.....	22
Decorative Finials.....	22
Round Finials.....	22
1 3/8" European Brackets.....	22
1 3/8" Wood Rings.....	22
Mini Simple Scroll.....	22
Small Simple Scroll.....	22
Leaf Sconce.....	22





Visit us today at [graberblinds.com](http://graberblinds.com)  
19-1029-02 (07/08)

Graber® is a brand of  
SPRINGS WINDOW FASHIONS  
the Best Experience Company 